

Interno



KONČAR – Digital

Digital transformation

for critical infrastructure

dr. sc. Stjepan Sučić

A century of excellence

- Since 1921
- Export to 130 markets worldwide
- Synergy of knowledge, expertise and experience

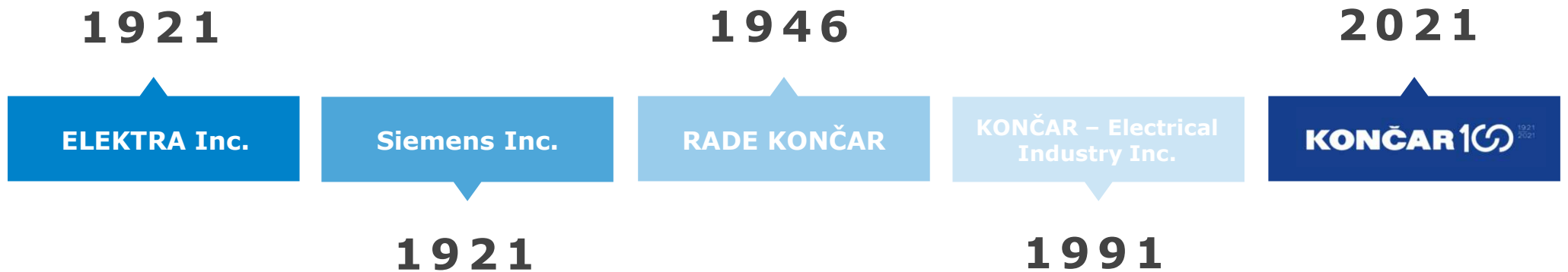

Company overview



KONČAR GROUP
15 companies and
1 affiliated company

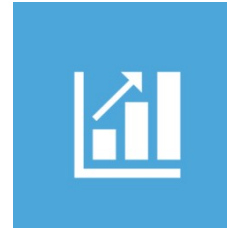

TOTAL INCOME*
900 million EUR
(2023)



PEOPLE*
4800+



EXPORT*
65% in total sales
revenue (2023)

**without affiliated company*

Interno

Export to 130 countries

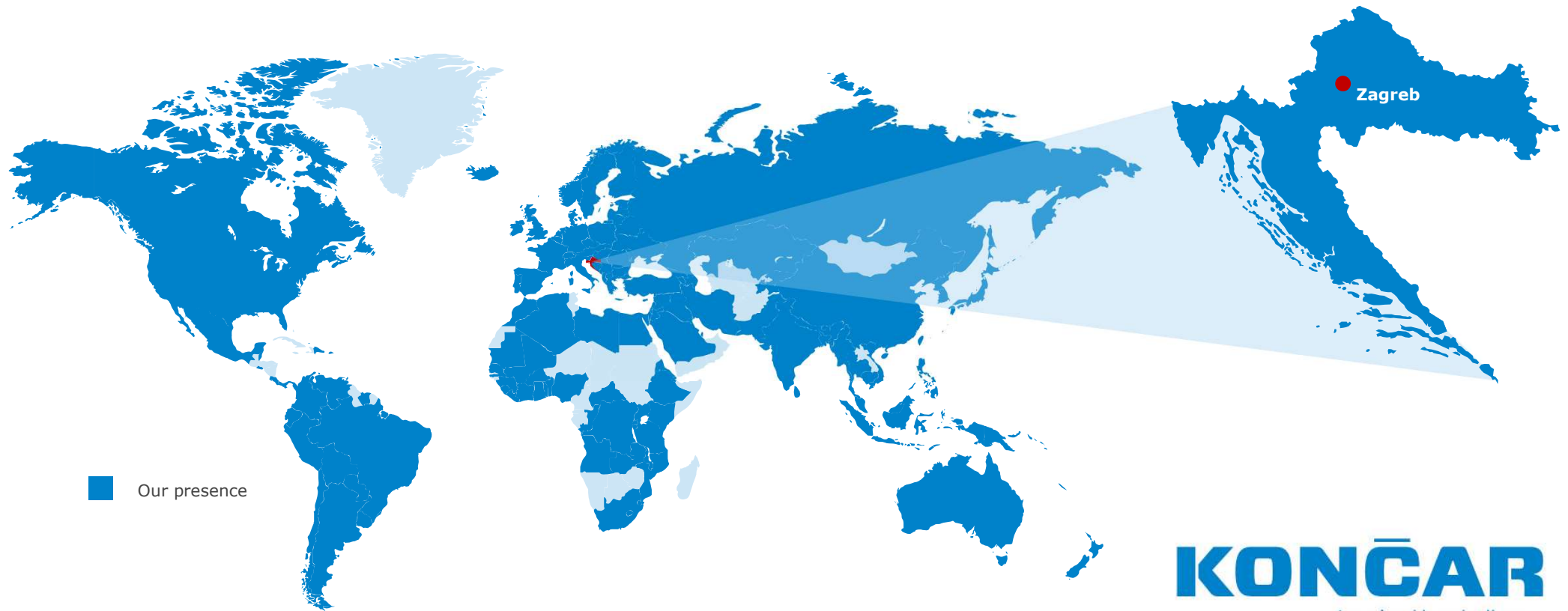

KONČAR
Inspired by challenge

Interno

KONČAR Group Business Areas

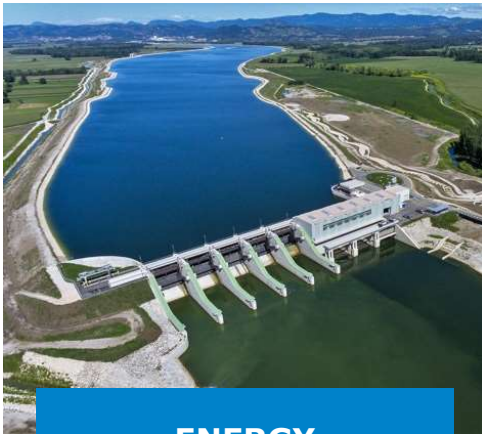

**ENERGY
PRODUCTION**



**ENERGY
TRANSMISSION AND
DISTRIBUTION**



TRANSPORTATION



**DIGITAL SOLUTIONS
AND PLATFORMS**

KONČAR
Inspired by challenge

Interno

KONČAR - Digital

DIGITAL SOLUTIONS AND PLATFORMS

- IT company of the KONČAR Group, formed in 2021
- Rich experience in development of industrial software
- Developing digital solutions & SW platforms
- Managing smart grids, critical infrastructure & cities
- Certified systems & processes for cyber security

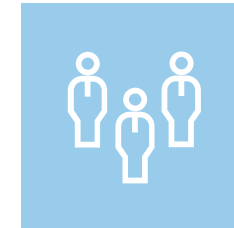

120+
experts



22+ mil. €
contracts in
2023



40+ years in SCADA development

- Next-gen platform
- State-of-the-art technologies
- Backward compatible
- Future-proof deployment
- Cloud-ready solutions

PROZA C/A



1979.

PROZA R/F

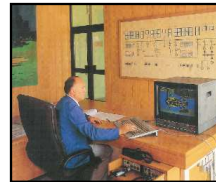

1984.

PROZA NET v3.0



2008.



1995.

PROZA D/R



2015.

PROZA NET v1.0



PROZA HAT

Standards compatibility

Active participation in IEC working groups!

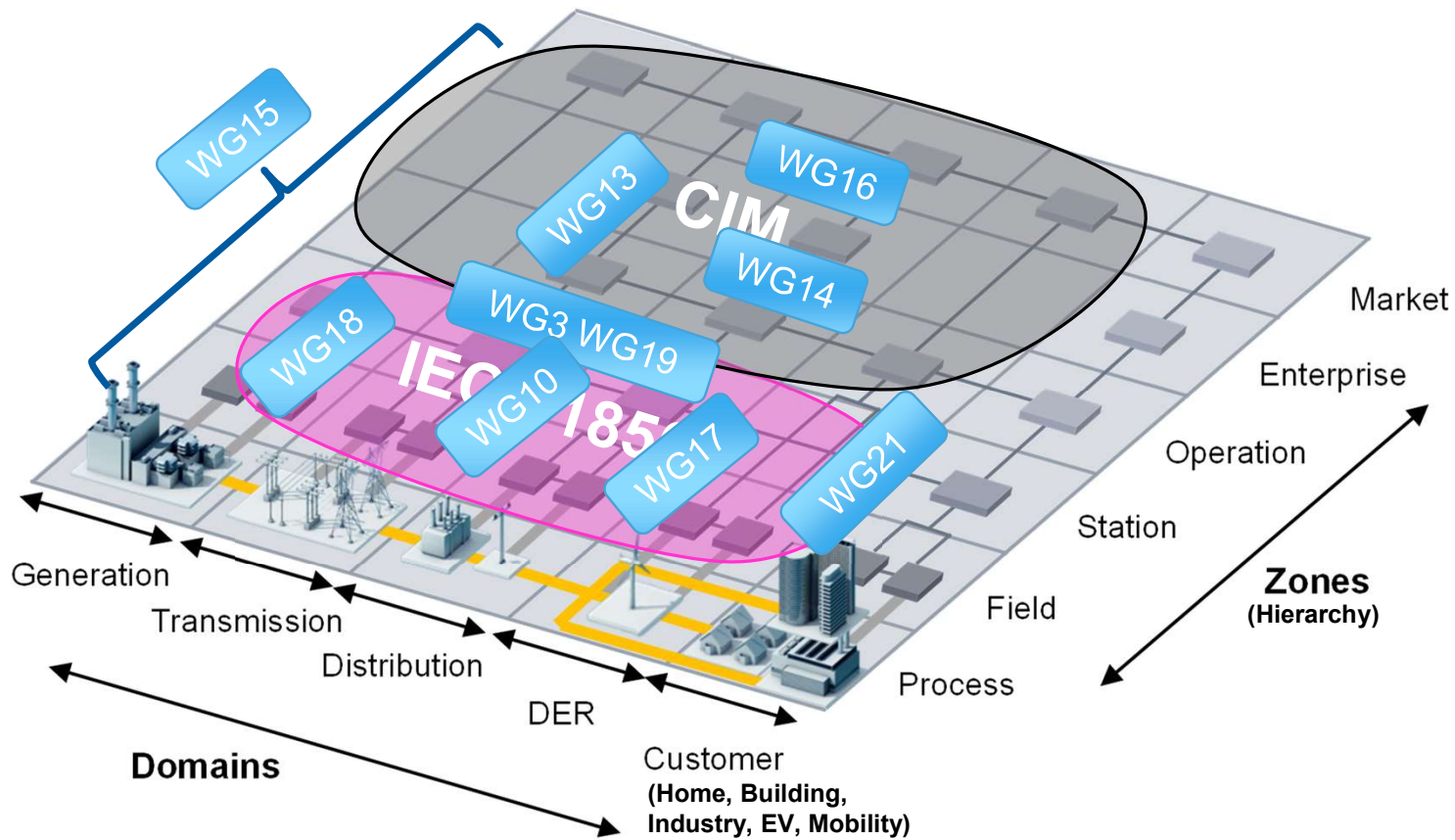

IEC 61850

IEC 60870-5-101/103/104

IEC 61970

IEC 61968

IEC 62351

IEC 62443

KONČAR

Inspired by challenge

Interno

Research projects

EU program
Horizon 2020



Regional management for transmission system



Active management for production



FLEXCoop

Energy communities



Big data in electric energy



Regional market for electric energy



ESCO model for households

ATTEST

DSO-TSO integration interface for data exchange



Large data sets for energy in buildings



Security for connected critical infrastructure

[*https://publications.jrc.ec.europa.eu/repository/handle/JRC125980](https://publications.jrc.ec.europa.eu/repository/handle/JRC125980)

KONČAR
Inspired by challenge

Interno

Key areas of digital transformation

Energy



Water



Cities



E-mobility



Data centers



KONČAR
Inspired by challenge

Energy & Smart Grids



Interno

Advanced management for energy and smart grids

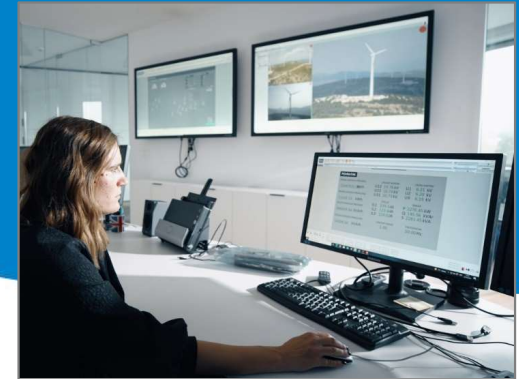

- Advanced SCADA systems
- Dispatching centers for electric power systems
- Management of production from renewable sources
- Data verification and management
- Advanced data analysis, alarms and reports

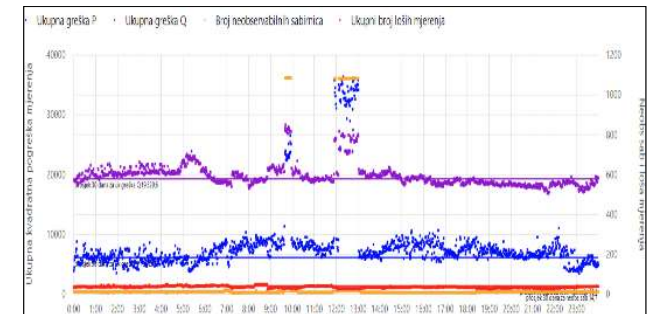
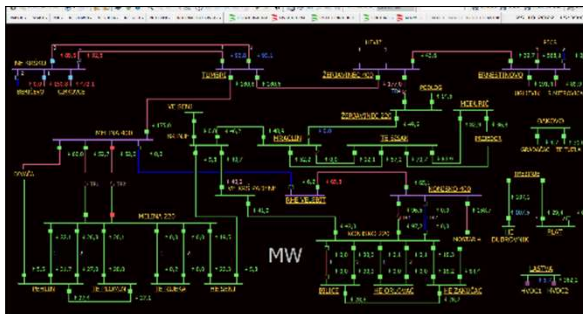

Interno

Transformer substation automation

- 500+ installations
- 40+ years experience
- 20+ countries

- Integration of equipment from different manufacturers
- Efficient engineering, simple to use & dependable
- Single configuration tool for complete engineering
- Supporting cyber secure communication protocols
- New technological solutions

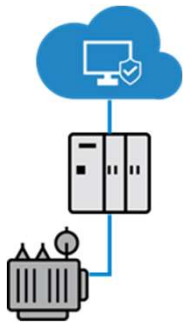

KONČAR
Inspired by challenge

Cyber security for critical infrastructure

- Security of data, information, processes and personnel
- Standards: IEC 62443, IEC 62351-3, IEC 62351-5, ISO 27001
- Secure encrypted communication
- Access control based on user roles
- Scientific research projects (CEKOM, Pretorian, CIP4SI, ...)



A cyber attack in Saudi Arabia failed to cause carnage, but the next attempt could be deadly

2017

At a time when the world faces a dangerous escalation in cyber warfare, a series of assaults on petrochemical companies in Saudi Arabia – possibly backed by nation states – has caused alarm

THE HENRY M. JACKSON SCHOOL OF INTERNATIONAL STUDIES
UNIVERSITY of WASHINGTON

2014

ABOUT / PEOPLE / ACADEMIC PROGRAMS / CENTERS & RESEARCH / ADVISING

Cyberattack on Critical Infrastructure: Russia and the Ukrainian Power Grid Attacks

South Korean nuclear operator hacked amid cyber-attack fears

2014

Operator begins two-day exercise after suspected hacker tweets information on KHNP plants and its staff

Stanford Center for International Security and Cooperation
Freeman Spogli Institute

2007

About Research Education People News Events

< All CISAC News

February 3, 2015

Stuxnet: The world's first cyber weapon

KIM ZETTEL SECURITY JUL 11, 2011 7:00 AM

How Digital Detectives Deciphered Stuxnet, the Most Menacing Malware in History



Water

Interno

KONČAR – Digital in water supply and drainage

**Large & challenging
projects**

**Digital solutions &
platforms**



Complete solutions covering all areas

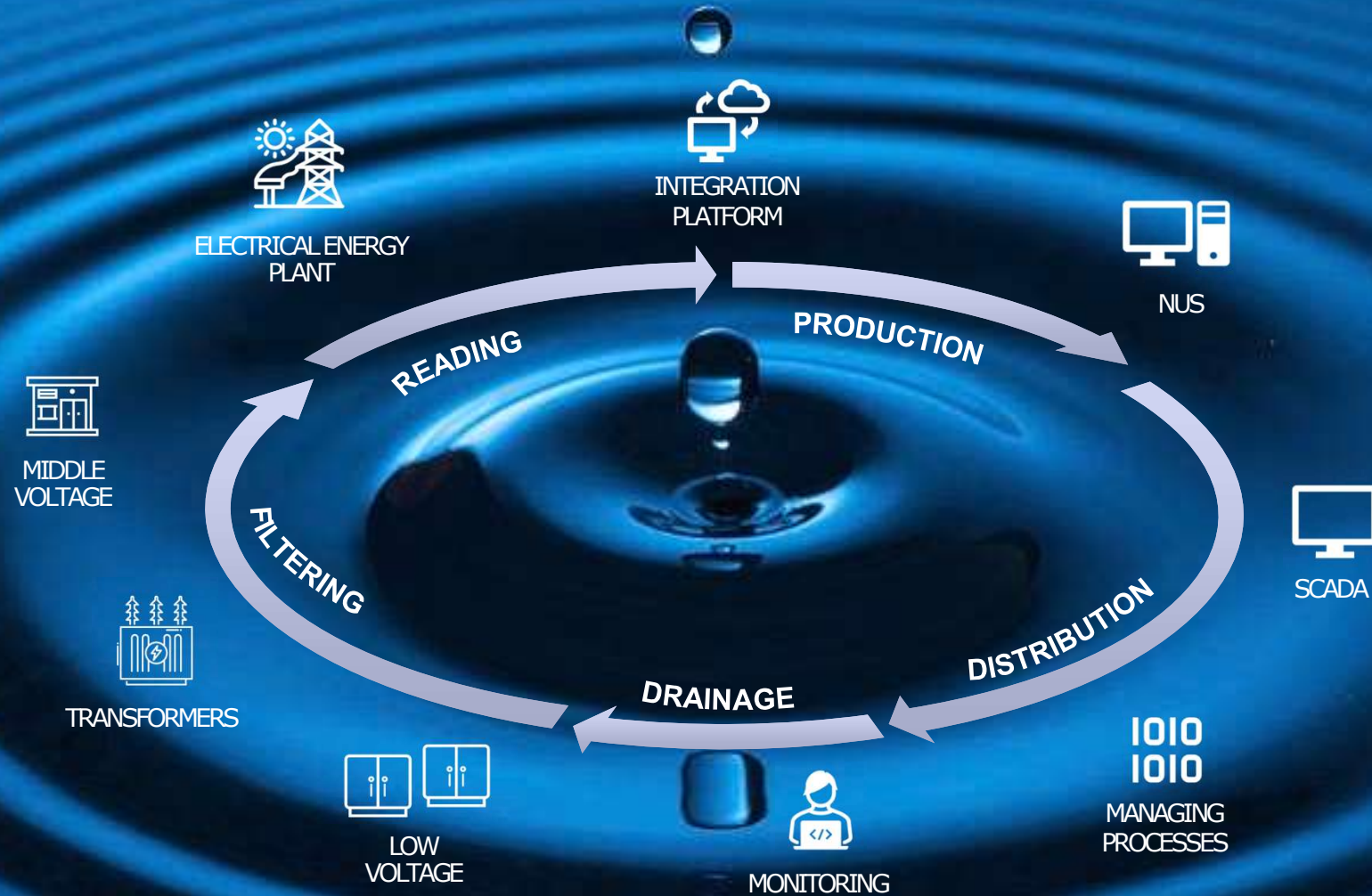

Cities



Končar MARS SW platform for smart cities

- Digital management for urban infrastructure
- Automatic remote reading, analysis, reports and alarms in real time
- Managing energy efficiency, measuring consumption and detecting losses
- Air quality, noise, parking, lighting, etc.

Highlighted

- **Končar MARS**
- SW IoT platform
- LoraWAN, NB-IoT, LTE-M GPRS/3G/4G/5G,...
- Web interface

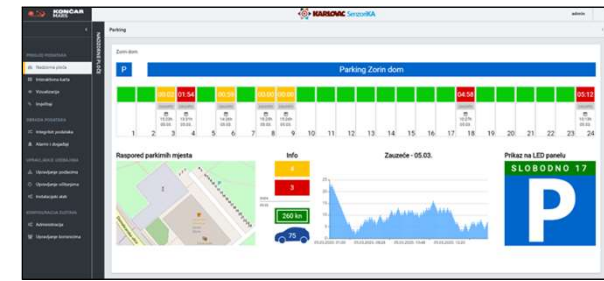
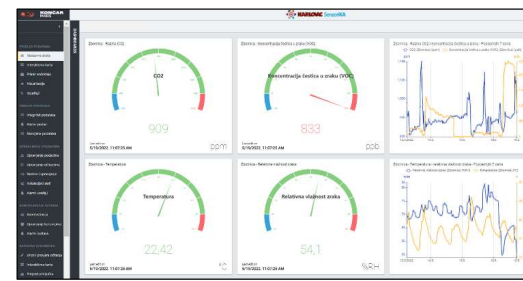
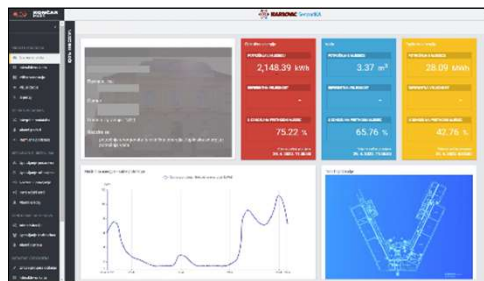

Interno

Project: Smart city Karlovac (SenzoriKA)



Robert Vodopić,
head of the smart city
department in the
Administrative Department
for City Development and
EU Funds

„ Everything is monitored through the city's central Končar MARS system, with which, thanks to digital technologies, we provide a better service, but also considerable savings and greater efficiency in the provision of public city services to the citizens of the city of Karlovac.”

KONČAR
Inspired by challenge

E-mobility



Electric mobility

- Great for the environment, but requires infrastructure
- Especially challenging for public and freight transport
- Part of future smart grids
- Extensive experience in the construction of power infrastructure
- Digital solutions for monitoring and management
- Greater security, availability and economy

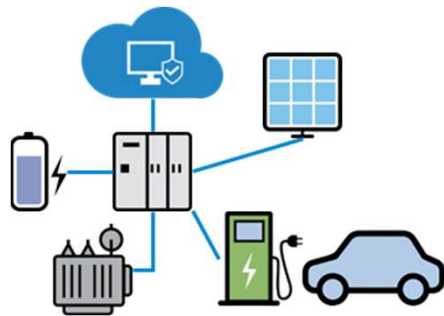

KONČAR
Inspired by challenge

Data Centers



Managing digital infrastructure

- Data centers are an integral part of digital transformation
- Large consumers of energy, IT and communication resources
- Special energy solutions and uninterrupted power supply
- Digital monitoring and management
- Improving resilience and economy
- Digital Realty and HZMO use our solutions

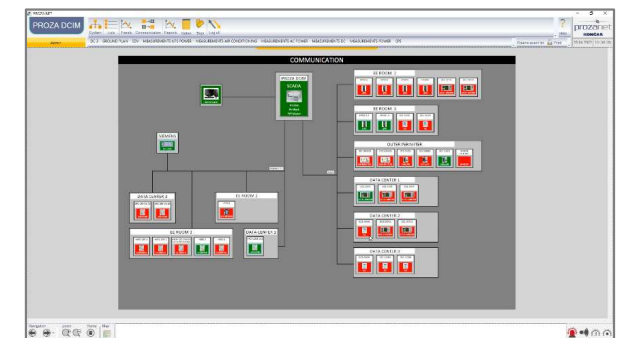
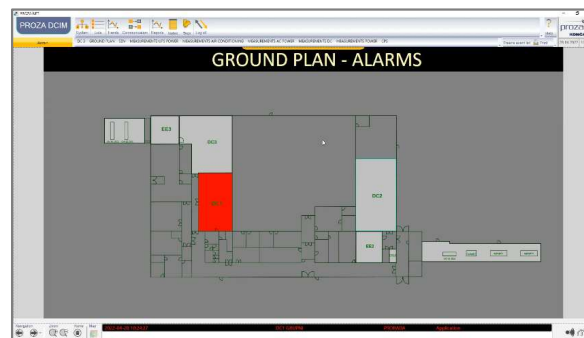

Interno

Thank you for the attention

KONČAR
Inspired by challenge

Stjepan Sučić

info.digital@koncar.hr

